



Print Place Cards Using Microsoft Word Mail Merge Microsoft Word for Mac 2008

Start Mail Merge

Open Word with a new blank document.

Click **Tools > Mail Merge Manager**.

The *Mail Merge Manager* opens, guiding you through the rest of the process in 6 steps.

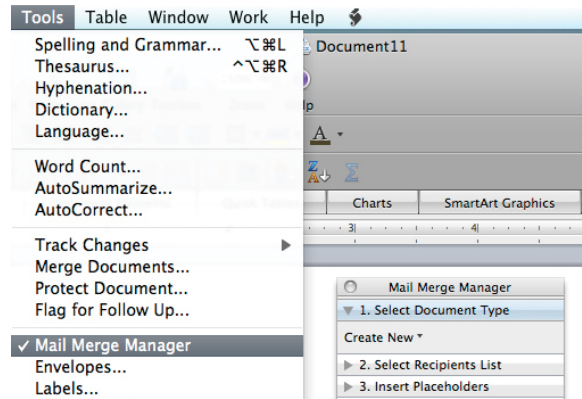

1. Select a Document Type

In Step 1, *Select Document Type*, you will be choosing the type of document you are working on and changing its layout.

Click **Create New > Labels**. The *Label Options* window opens.

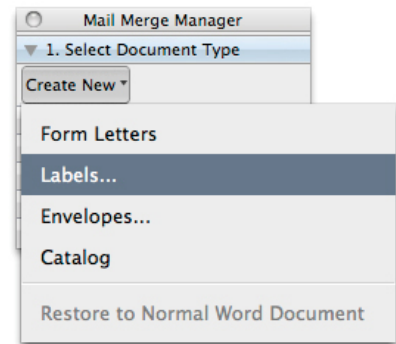

Edit Document Layout

Under *Label products* in the *Label Options* window select **Other**.

Click **New Label > OK**.

The *New Custom* window opens

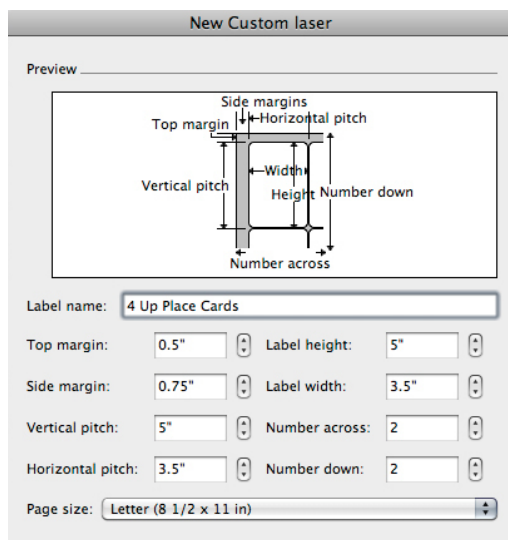
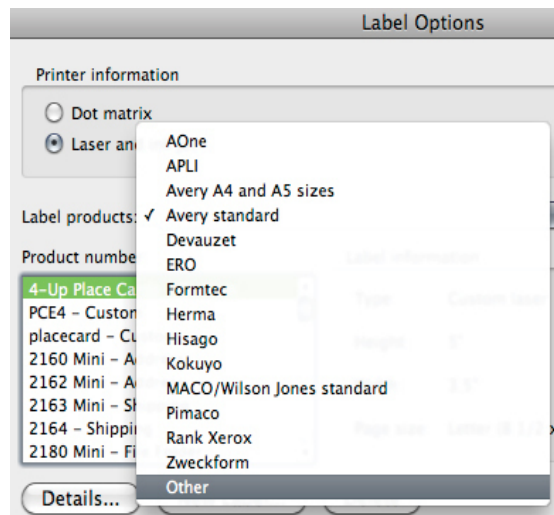

In the *Label name* field, enter a custom name for your label template.

Enter the following values into the rest of the fields to create a template for LCI's 4-Up Place Cards:

- Top margin** = .5
- Side margin** = .75
- Vertical pitch** = 5
- Horizontal pitch** = 3.5
- Label height** = 5
- Label width** = 3.5
- Number across** = 2
- Number down** = 2

For *Page size*, select **Letter (8 1/2 x 11 in)**.
Click **OK**.

Your custom template appears in the *Product number* field.
Make sure it is selected.

Click **OK**.

Your custom template is now on screen showing 4 quadrants
sized to match the 4-Up Place Cards layout.

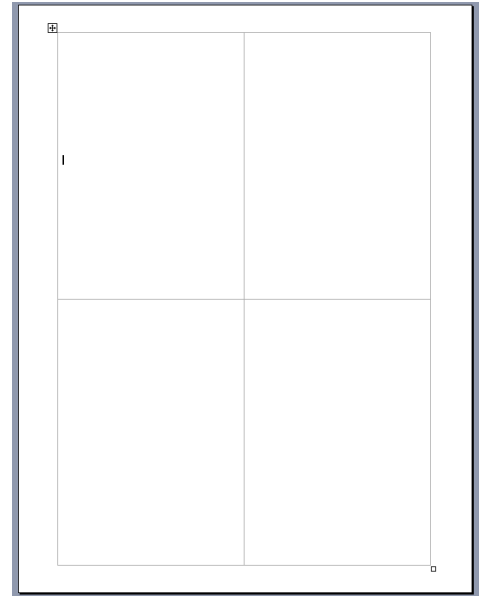

2 Select Recipients

Under step 2, *Select Recipients List*, click **Get List > Open Data Source**.

Navigate to the spreadsheet of names and table numbers that you have
previously made.

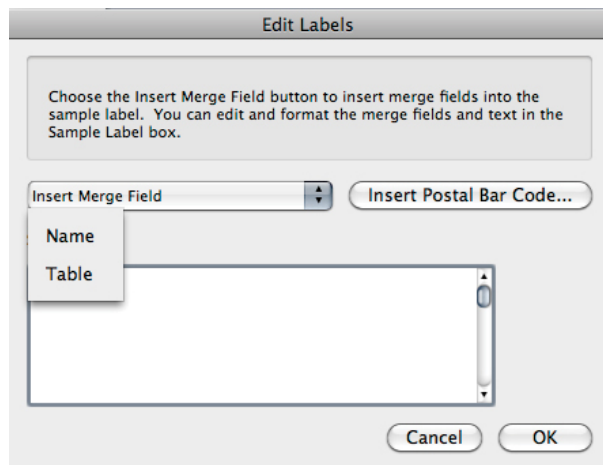
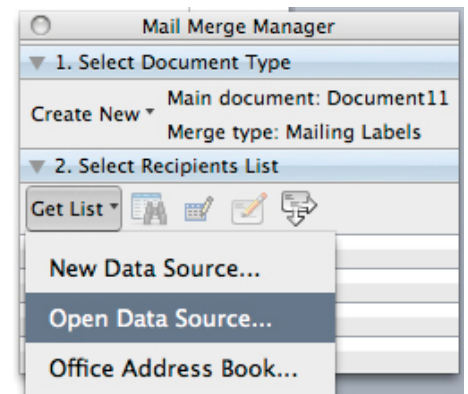

The *Edit Labels* window opens:

Under the *Insert Merge Field* menu select the field you wish to
use on your place cards by clicking on each individually, then
clicking **OK** after each.

Your cursor should be now be in the upper left quadrant along
with the merge fields you entered.

The other quadrants show <<Next Record>> along with your
merge fields.

3 Arrange Your Place Cards

In Step 3, you'll set up the default format for your place cards using the first four place cards.

Arrange and format the merge fields as you like in the lower half of each quadrant.
Be careful not to disrupt the template layout. If you change the layout by mistake, use **Edit > Undo**.

Don't forget to get creative with fonts!

When you are satisfied with the layout, proceed to step 4.

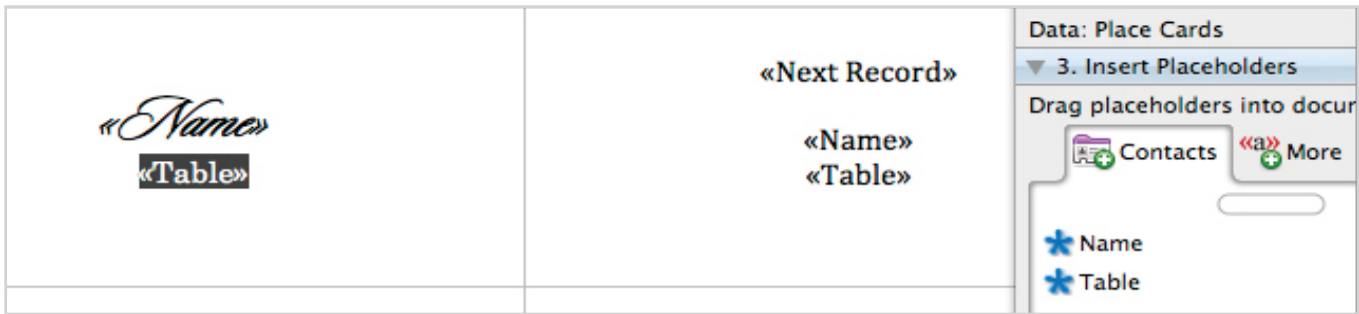

4. Filter Recipients

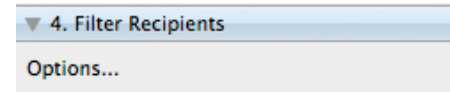

Step 4 provides options for filtering names on your list. This will only be used if you wish to omit some names that are in your database file, or if you wish to reprint a few addresses from your merged document later on.

If your list is fine as is, proceed to step 5.

5. Preview Your Place Cards

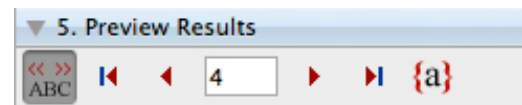

All of the information from your spreadsheet has populated into the document and you can preview each card by clicking the <<ABC>> and the << and >> buttons.

This is a good time to make sure none of the names are too large to fit on one line.

When everything looks good, you're ready to complete the merge.

6. Complete the Merge & Print

This is the appropriate time to print one place card sheet as a test.

In step 6, click the *Merge to Printer* icon then select **Current Record**.

This prints just the 4 place cards on the screen, not the entire collection.

A print window appears which brings up your print driver.

Since you are printing a standard 8 1/2 x 11 sheet, you will not need to set up your print driver to recognize custom dimensions.

After printing the test, if everything is properly positioned, click **All** to print the entire list.

